

Somfy

Glydea Motorised



The trademarked Glydea curtain track system is quiet, discreet, flexible and robust, offering personalised solutions to improve the image, usage and functionality for our customers' environment. Glydea solutions are designed extend the lifespan of the curtains, offering increased value for users. The system is also compatible with Somfy's range of sensors and controls, to maximise energy efficiency and create fully automated solutions.

Somfy

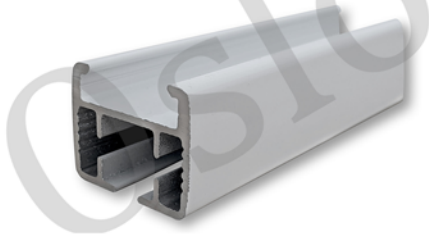

SOMFY20

Somfy Tracking 6.3m Lengths

Colour: White

Qty: Made To Measure Orders Only



SomfyR1

Situo 1 RTS Pure 1 Channel

Colour: White

Qty: Each



SomfyR2

Situo 2 RTS Pure 2 Channel

Colour: White

Qty: Each



SomfyR5

Situo 5 RTS Pure 5 Channel

Colour: White

Qty: Each



SOMFYR6

telis 6 Chronis RTS with Timer

Colour: White

Qty: Each



SOMFYR16

Telis 16 RTS

Colour: White

Qty: Each

Somfy



SOMFYCONNEX

CONNEXOON WINDOW RTS

Qty: Each

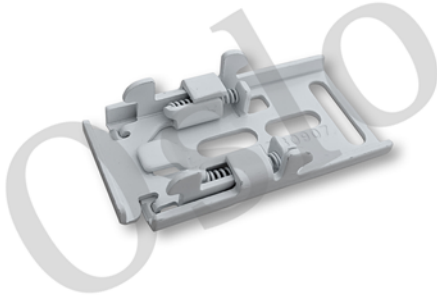

SOMFYSP

One Touch Ceiling Bracket

Colour: White

Qty: Each



SOMFYSW

Swivel Ceiling Bracket

Colour: Zinc

Qty: Each

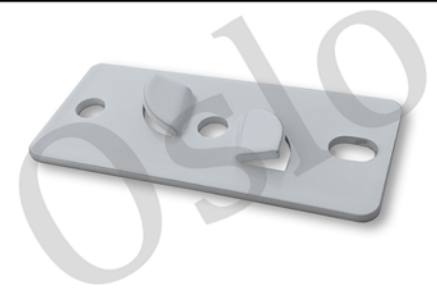

SOMFYPL

Ceiling Fix Plate

Colour: White

Qty: Each



SOMFYSF

Somfy Face Fix to suit bracket covers

Colour: White

Qty: Each

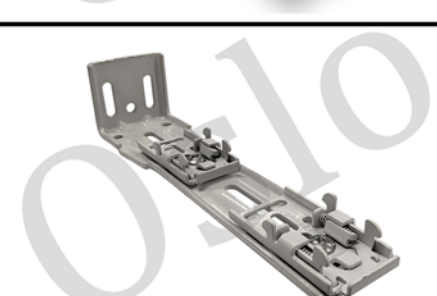

SOMFYDF

Somfy Face Fix to suit bracket covers

Colour: White

Qty: Each

Somfy



SOMFY AF

Somfy Adjustable face fix Brackets

Colour: White

Qty: Each



SOMFY AFS

Somfy Adjustable face fix Brackets

Colour: White

Qty: Each



SOMFYJOIN

Somfy Joiner

Colour: Silver

Qty: Each



SOMFYCH

IRSIMO Charger, ANZ Plug

Colour: White

Qty: Each



Somfy Molex

Molex Lead

Colour: White

Qty: Each



Somfy Molex 3 PIN

Molex Lead with 3 pin plug

Colour: White

Qty: Each,

Available in: 2.3m, 5m, 10m

Somfy

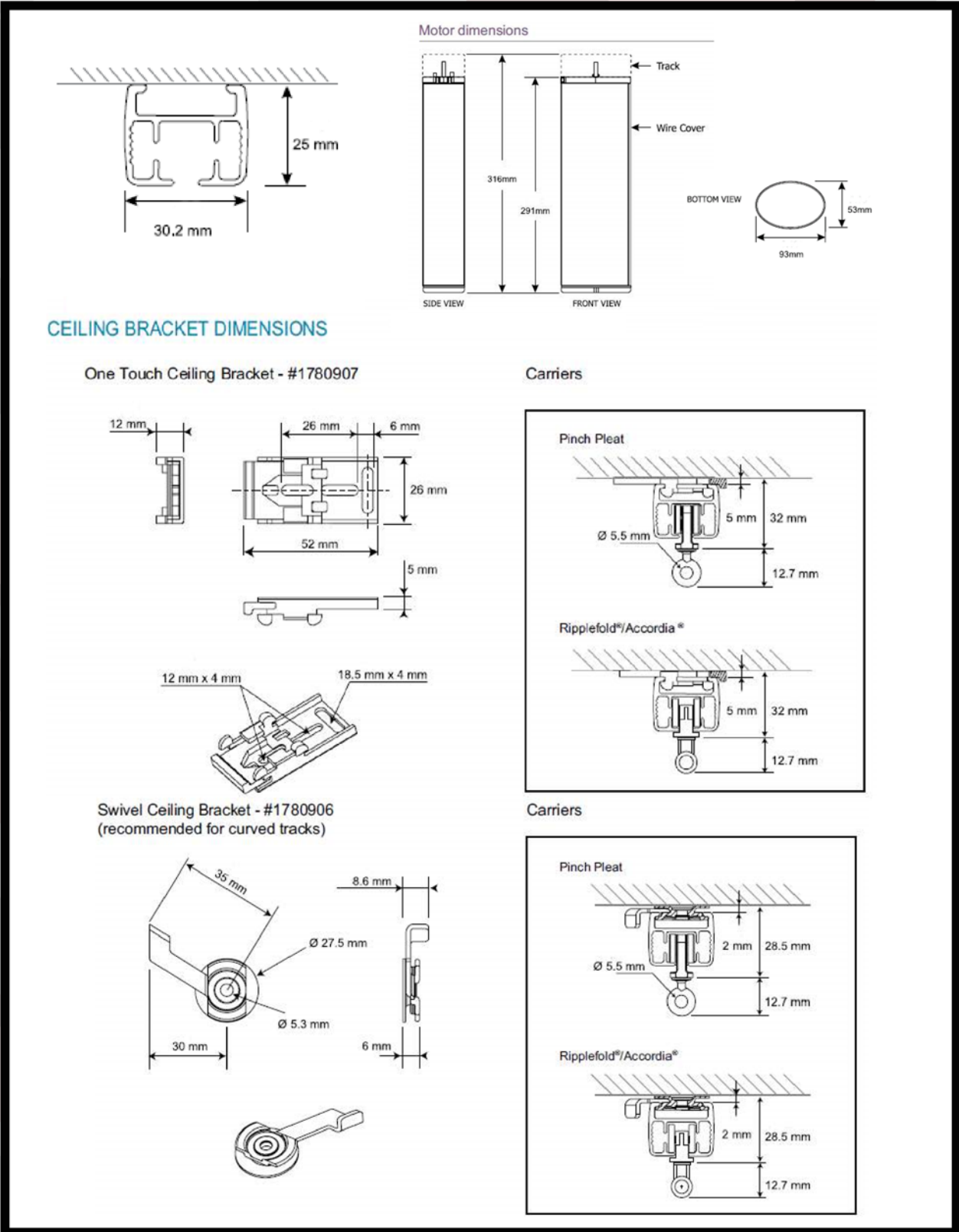

Somfy

WALL BRACKET DIMENSIONS

Adjustable Wall Mount Bracket - #1780909

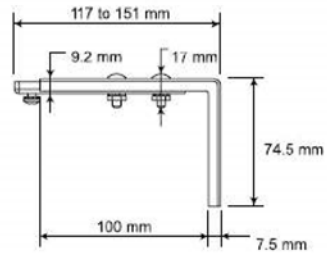
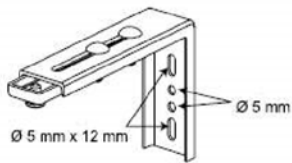

Double Adjustable Wall Mount Bracket - #1780910

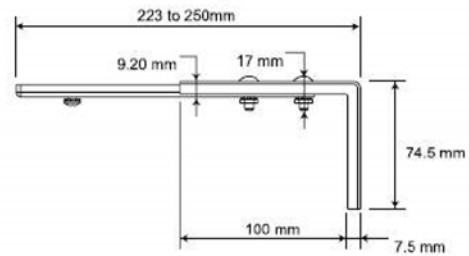
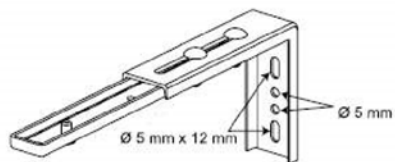

Somfy

CONNEXOON
PRODUCT SPECIFICATIONS



The simplest choice
for controlling motorised
applications from
home or away

PRODUCT FUNCTIONALITIES



Individual Control

Connect up to four smartphone devices, each with individual, personalised control



Centralisation

All of your Somfy RTS solutions in one place, allowing you to open and close with just one touch



Timer

Schedule the opening and closing of your equipment at the time and date of your choice



Ambiance Replay

Register a position for your window coverings and your lights to reproduce your favourite moments



Remote Access

Maximise the many benefits such as energy saving and privacy even when you're away from home

somfy Building happiness



Somfy

CONNEXOON PRODUCT SPECIFICATIONS

OPERATING PRINCIPLE



RTS Communications
between Connexoon Window RTS and the home's devices.



Ethernet Communications
between the router and the Connexoon Window RTS device.



Remote Control (3G/4G)
Commands sent from the smartphone via the 3G/4G Internet network.



Control from Home
Commands sent from the smartphone via the home's WiFi.

COMPATIBLE END PRODUCTS



Lights



Roller Blinds



Venetian Blinds



Curtains

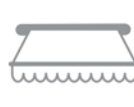

Awnings



External Blinds



Roller Shutters

TECHNICAL CHARACTERISTICS

Operating Temperature	5°C to 35°C
Protection Rating	IP 30
Radio Frequency	RTS: 433.42 MHz
Radio Hz Range	200 metres in open field, 20 metres through 2 reinforced concrete walls
Dimension (H x W x D mm)	110 X 71.5 X 24 (without plug)

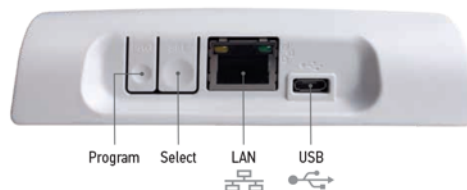

Product Description	Connexoon Window RTS
Reference	1811591

SOMFY Pty Limited – ABN 77 003 917 244 – 20/38-46 South St, Rydalmere NSW 2116 – T +61 (0)2 8845 7200 – somfy.au@somfy.com

somfy Building happiness

www.somfy.com.au

Somfy

